

# Mood'

instruction manual



**Manutti'**

# Mood

A wide range of sizes, finishes and table tops allows for seemingly endless combination possibilities within the Mood table collection. These fun, versatile and lightweight tables are a perfect addition to any outdoor lounge, regardless of whether you are looking for a classy side table or a playful mix of nesting coffee tables.

Here is how to start your outdoor moments of peace and connection under the sun.

# How to assemble teak & teak scuro tables

## Parts



x 1 frame

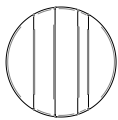

x 1 top



x 3 snap-on connector



x 3 bolt M6



x 1 hex key

## Installation

Snap the snap-on connector around the frame.

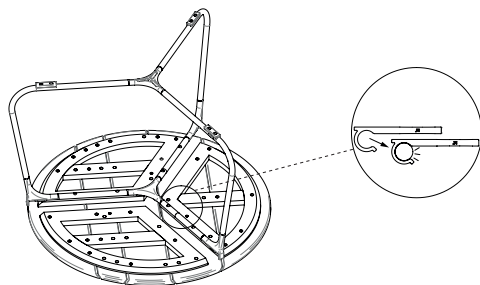

Position the snap-on connector nearby the threaded hole. Position the bolt.

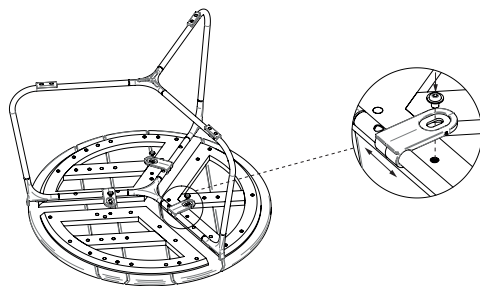

Gently tighten the bolt.

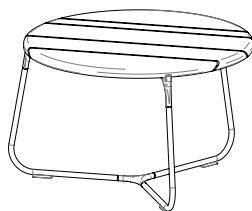
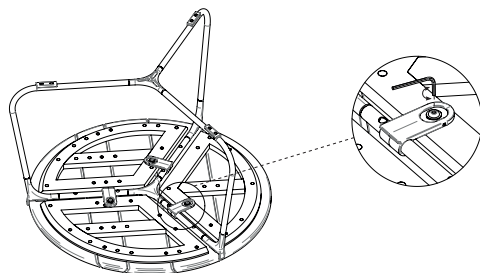

# How to assemble ceramic 6mm tables

## Parts



x 1 frame

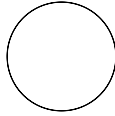

x 1 top



x 3 nut M5 (Ø42)  
x 6 (Ø60/Ø80/Ø100)



x 3 washer (Ø42)  
x 6 (Ø60/Ø80/Ø100)

## Installation

Place the frame on the table top and add a washer and nut

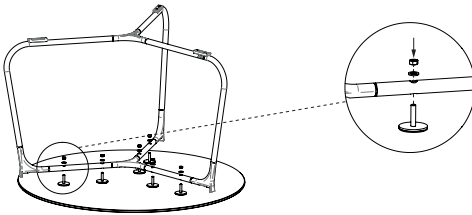

Gently tighten the nut.

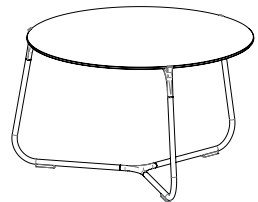
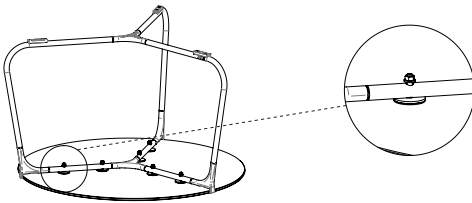

# How to assemble ceramic 12mm & Trespa tables

## Parts



x 1 frame

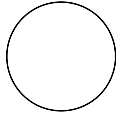

x 1 top



x 3 snap-on connector



x 3 bolt M6



x 1 hex key

## Installation

Snap the snap-on connector around the frame.

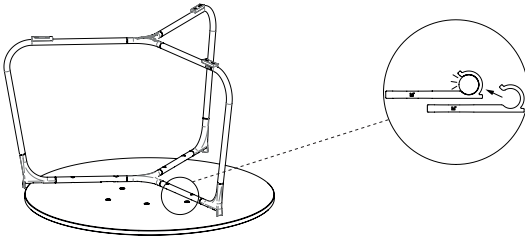

Position the snap-on connector nearby the threaded hole. Position the bolt.

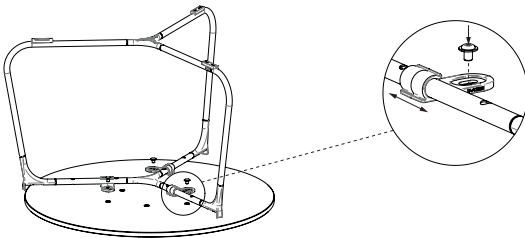

Gently tighten the bolt.

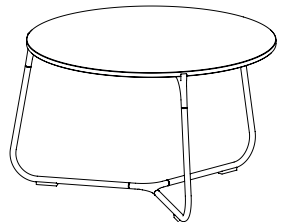
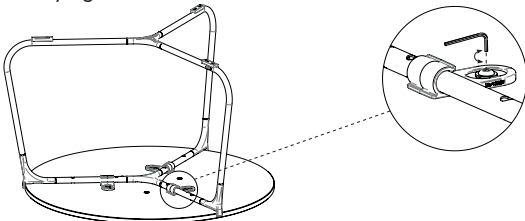

# How to assemble glass tables

## Parts



x 1 frame

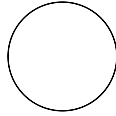

x 1 top



x 6 bumper

## Installation

Peel off one protective layer and stick to the frame.

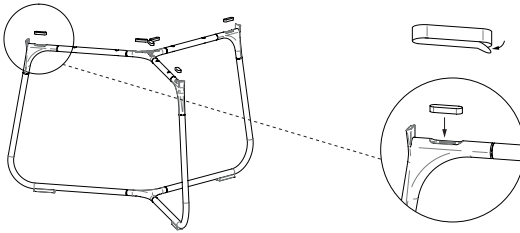

Peel off the other protective layer, and place the tabletop on the frame.

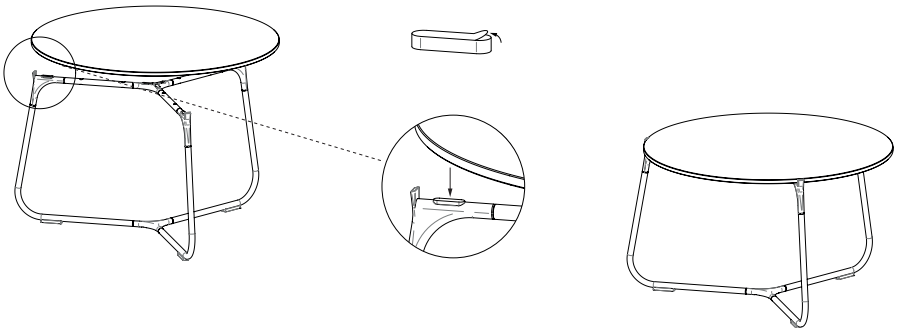

# Maintenance

Go to [manutti.com/maintenance](http://manutti.com/maintenance)

# Safety



**WARNING:**

Do not use a high pressure cleaner to clean your furniture.  
This may damage your furniture.

## **Need more assistance?**

Contact the Manutti customer service anytime and get all your questions answered at [support@manutti.com](mailto:support@manutti.com)